

ŽUMPA - 6 m³

PÔDORYS M1:25

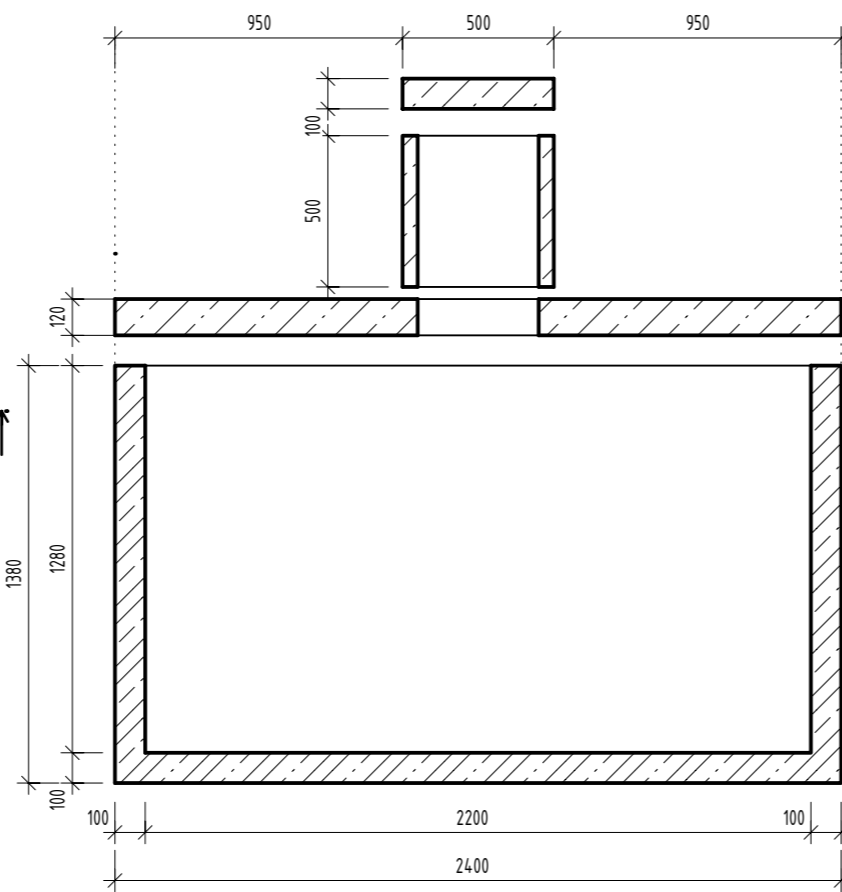

REZ 1-1 M1:25

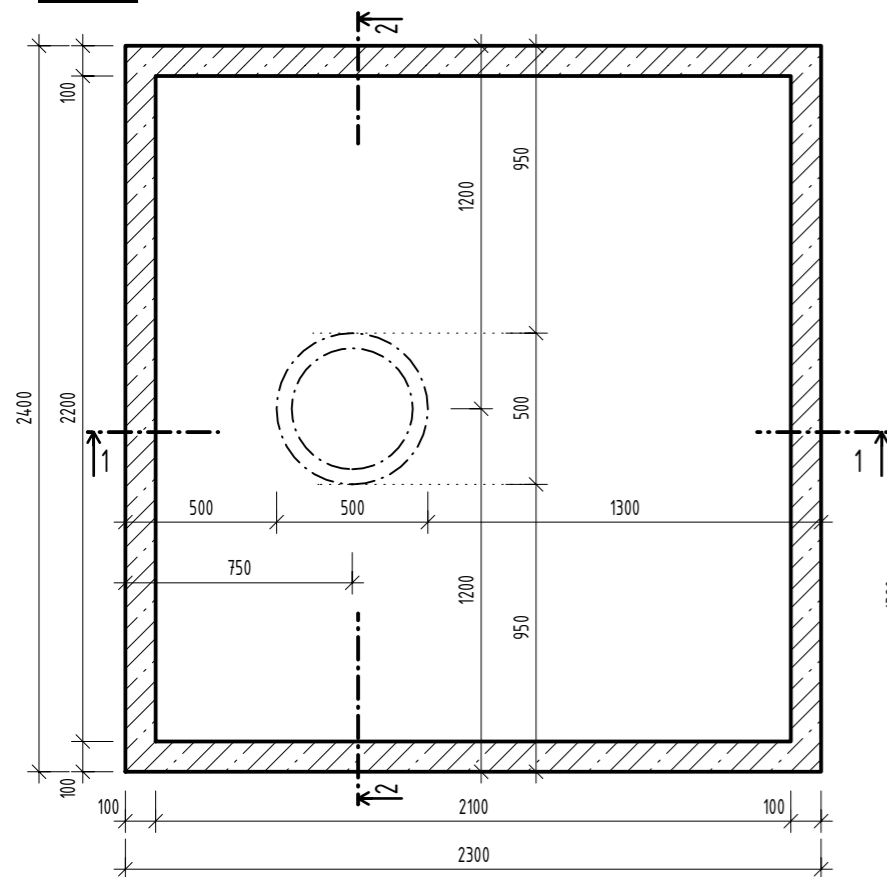
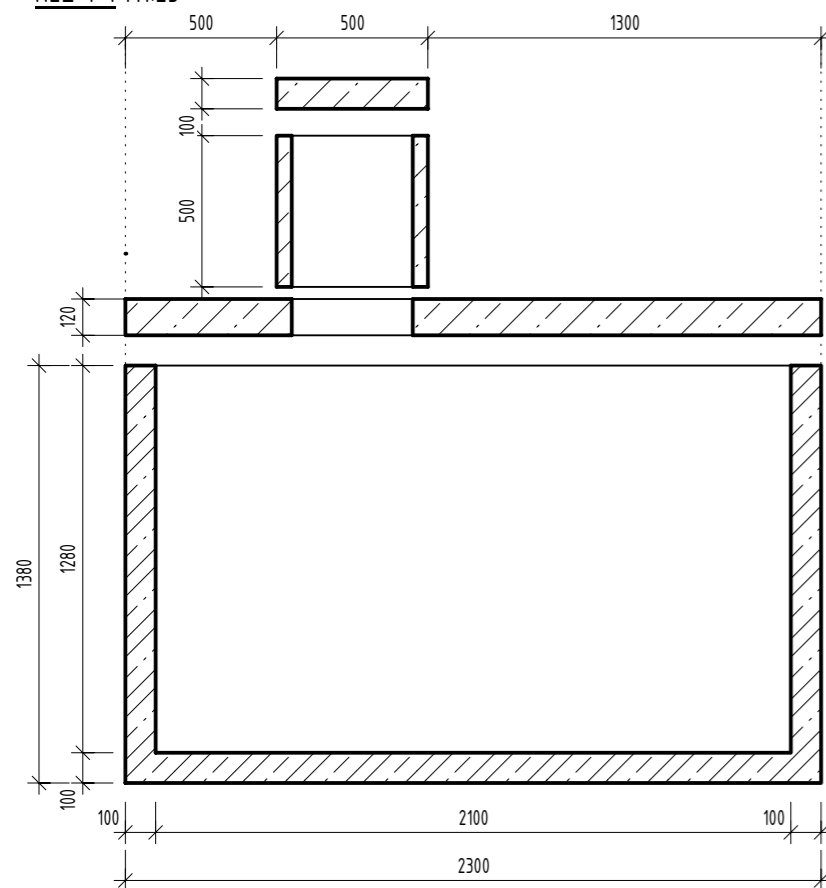

TECHNICKÉ PARAMETRE :

OBJEM: 6,0 m³

MATERIÁL: VODOSTAVEBNÝ ARMOVANÝ BETÓN

ROZMERY: dlxšxv: 2,3 x 2,4 x 1,5 m

HRÚBKA POKLOPU DOSKY: 0,12 m

