

ŽUMPA - 8 m³

PŮDORYS M1:25

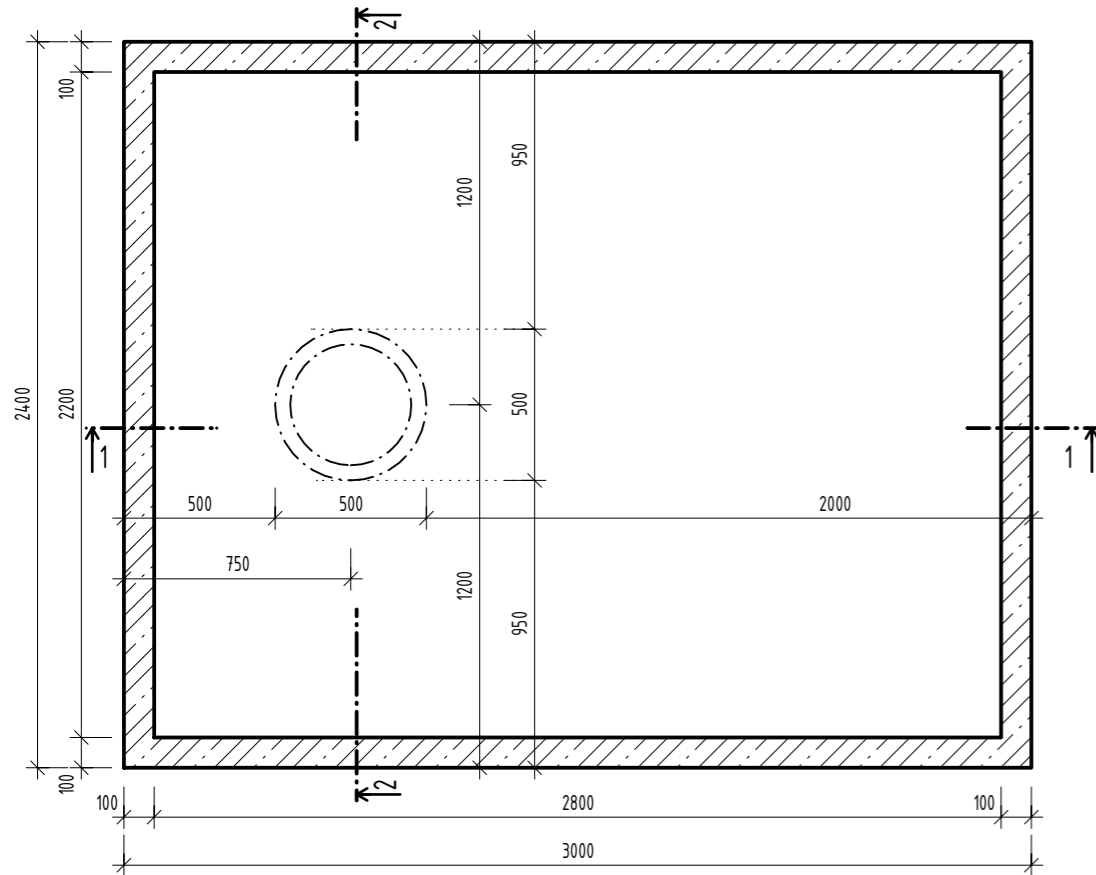

REZ 1-1 M1:25

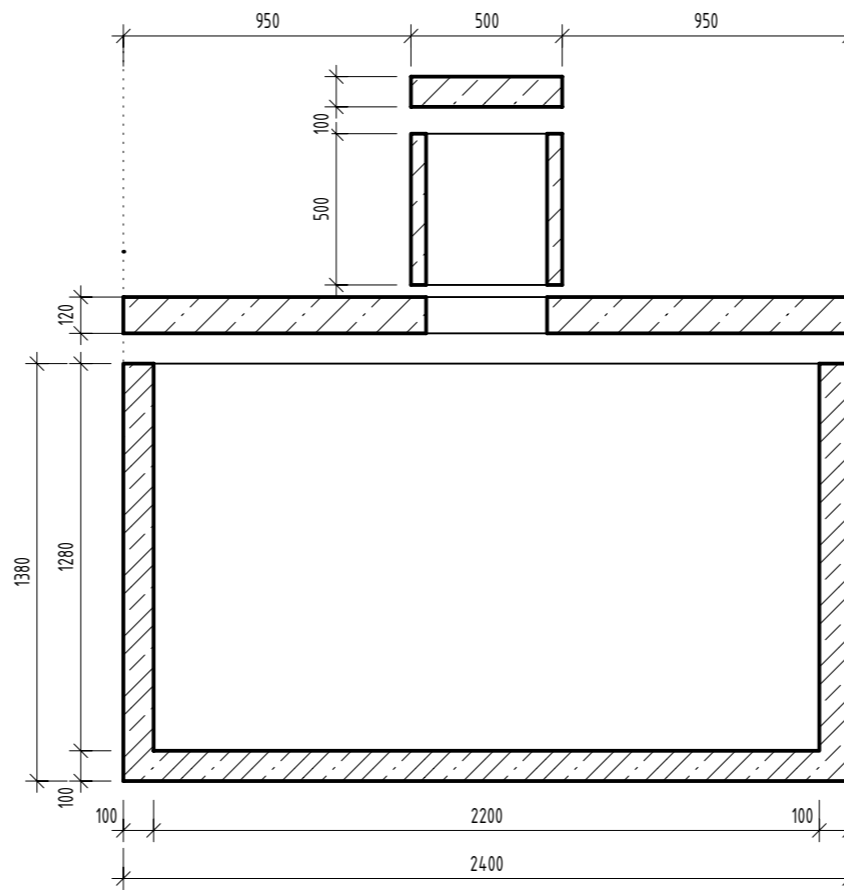
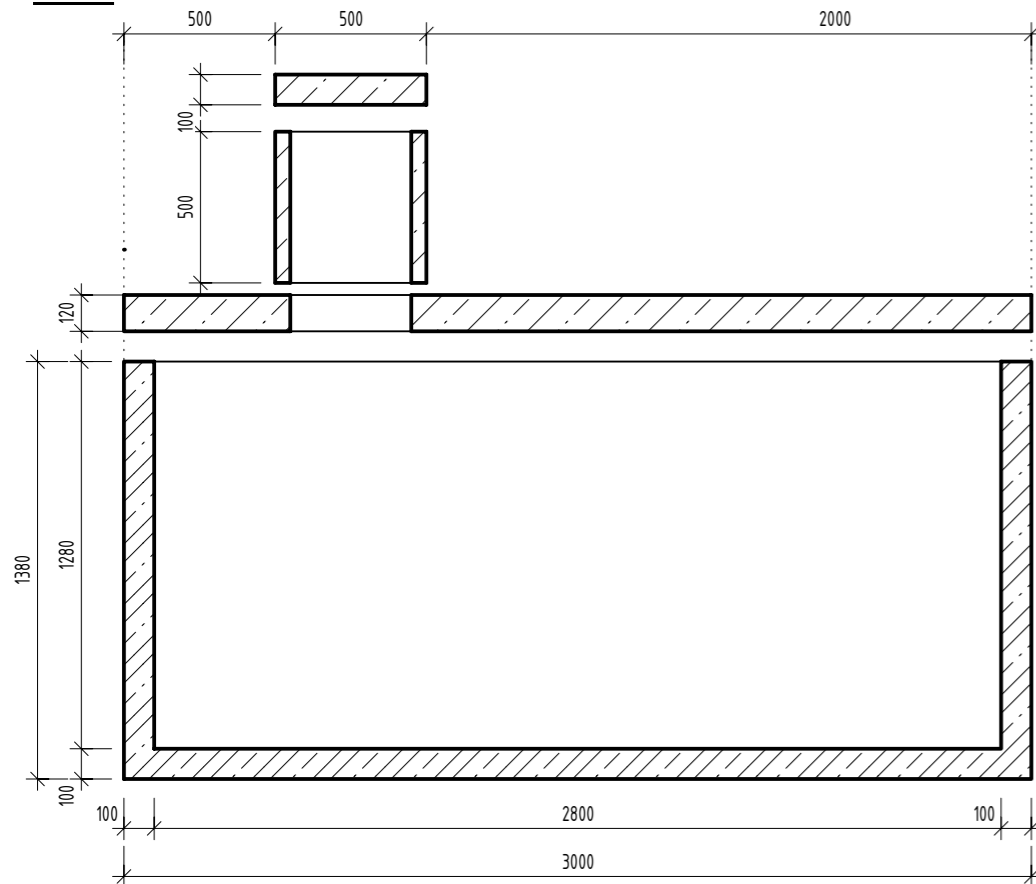

TECHNICKÉ PARAMETRE :

OBJEM: 8,0 m³

MATERIÁL: VODOSTAVEBNÝ ARMOVANÝ BETÓN

ROZMERY: dlxšxv: 3,0 x 2,4 x 1,5 m

HRŮBKA POKLOPU DOSKY: 0,12 m

